

Technologies to Reduce Power Consumption of Active RFID Readers

Shinzo Ohkubo and Kosei Takiishi

Two technologies and their effectiveness are described, devised with the aim of reducing the power consumption required for mounting an active RFID reader on a mobile terminal.

1. Introduction

New types of services are expected in the mobile ubiquitous environment [1], where all sorts of objects and computers exchange information either directly or through networks. In such an environment, Radio Frequency IDentification (RFID) is attracting interests in recent years as one of the realizable technologies for providing connectivity that includes various objects.

RFID systems consist of a radio tag for transmitting an ID and a reader for reading the ID, and have been utilized as a technology mainly for performing product identification and management by attaching a tag on an object. Classified broadly, there are two types of RFID systems: passive types, in which a tag transmits an ID using electrical current induced in its antenna by the incoming radio frequency signal transmitted from a reader; and active-types, where a tag contains its own battery and can transmit an outgoing ID signal without the need for an external power source.

Active types have the feature of longer communication distances compared with passive types, even with a hand-held reader having restriction on battery capacity and antenna diameter, because the active type includes a battery mounted on the tag. Due to this difference in communication distances, serviceability may be characterized as follows.

With the passive type having a shorter communication dis-

tance, a user can obtain an ID by intentionally holding a reader against a tag. That is, in order to initiate data transmission, user intention is required. On the other hand, since the active type has a communication range of several meters, a user carrying a reader can obtain an ID simply by approaching a tag. That is, to receive data from an active RFID tag, the intention of a user is not necessarily required. Accordingly, with the active type, it is possible to realize data transmission service either by supporting a user-initiated action or after a user is given an “awareness” by a reader that has received an ID from a nearby tag (**Figure 1**).

In a mode with the reader placed in a fixed location and a user carrying an object with a tag, however, the restriction on the communication distance can be eased by the user and tag approaching the reader, a network for providing feedback to the user of the ID obtained by the reader in the fixed location is required, resulting in a service expansion that is considered to be somewhat limited. This means that a mode in which a user carries the reader is essential, and if the reader function can be mounted on a mobile terminal, user-friendliness is further improved.

Figure 2 shows examples of service using an active RFID reader mounted on a mobile terminal. The monitoring system service shown in Fig. 2 (a) requires a reader to continue monitoring an ID, while the detection system service shown in Fig. 2 (b) requires a reader to detect an ID.

Currently, commercially-available active RFID reader deemed to be difficult to be mounted on a mobile terminal due

to power consumption, even after chip integration is performed. Accordingly, new technology with the aim of reducing power consumption is required.

This article describes the devised technologies for reducing the power consumption of a reader, with the goal of mounting an active RFID reader on a mobile terminal.

2. Technologies for Reducing Power Consumption of a Reader

Here we describe the TimeHopping (TH)^{*1} access/intermittent reception control method, and multiple zero-crossing demodulation using an under-sampling^{*2} technique below.

2.1 TH Access/Intermittent Reception Control Method

Reduced power consumption of the monitoring system service can be realized by intermittent reception control, which performs reception operations only at the time when an ID is transmitted from a tag. To perform intermittent reception operations, one method is for tags to periodically transmit the ID. However, in this case, the reader tends to incur continual reception failures due to collisions caused by the series of signals received from a number of various tags. Accordingly, it is important to reduce the number of continual reception failures.

This technology uses an access/intermittent reception control method in which a TH sequence is generated based on an ID, and individual tag transmission timing is randomized according to the generated TH sequence that causes a reduction in the continual collision rate, while a reader performs intermit-

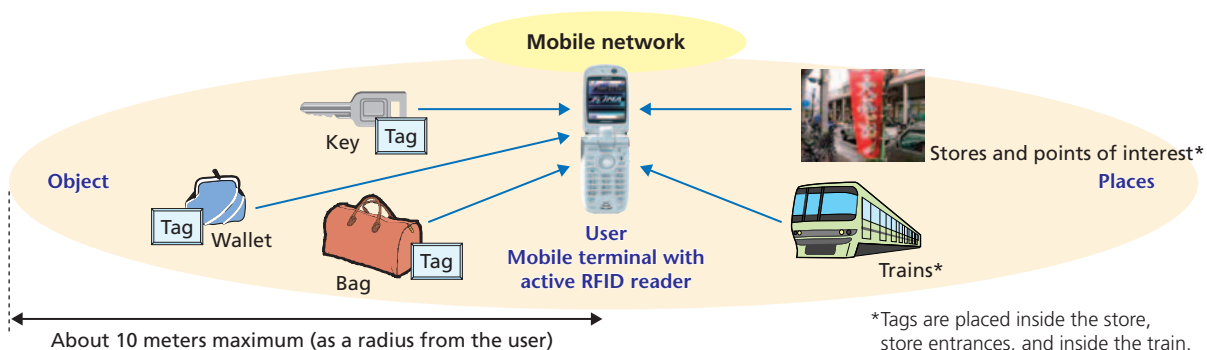

Figure 1 Mobile terminal with active RFID reader

*1 TH: A method of changing transmission timings of a signal based on a pattern determined by a code sequence.

*2 Under-sampling: A sampling method which is used for converting signals of a high frequency range into a low frequency range, and performs sampling operations using a frequency lower than the carrier frequency, and equal to or greater than twice the one side of the frequency bandwidth transmission signal.

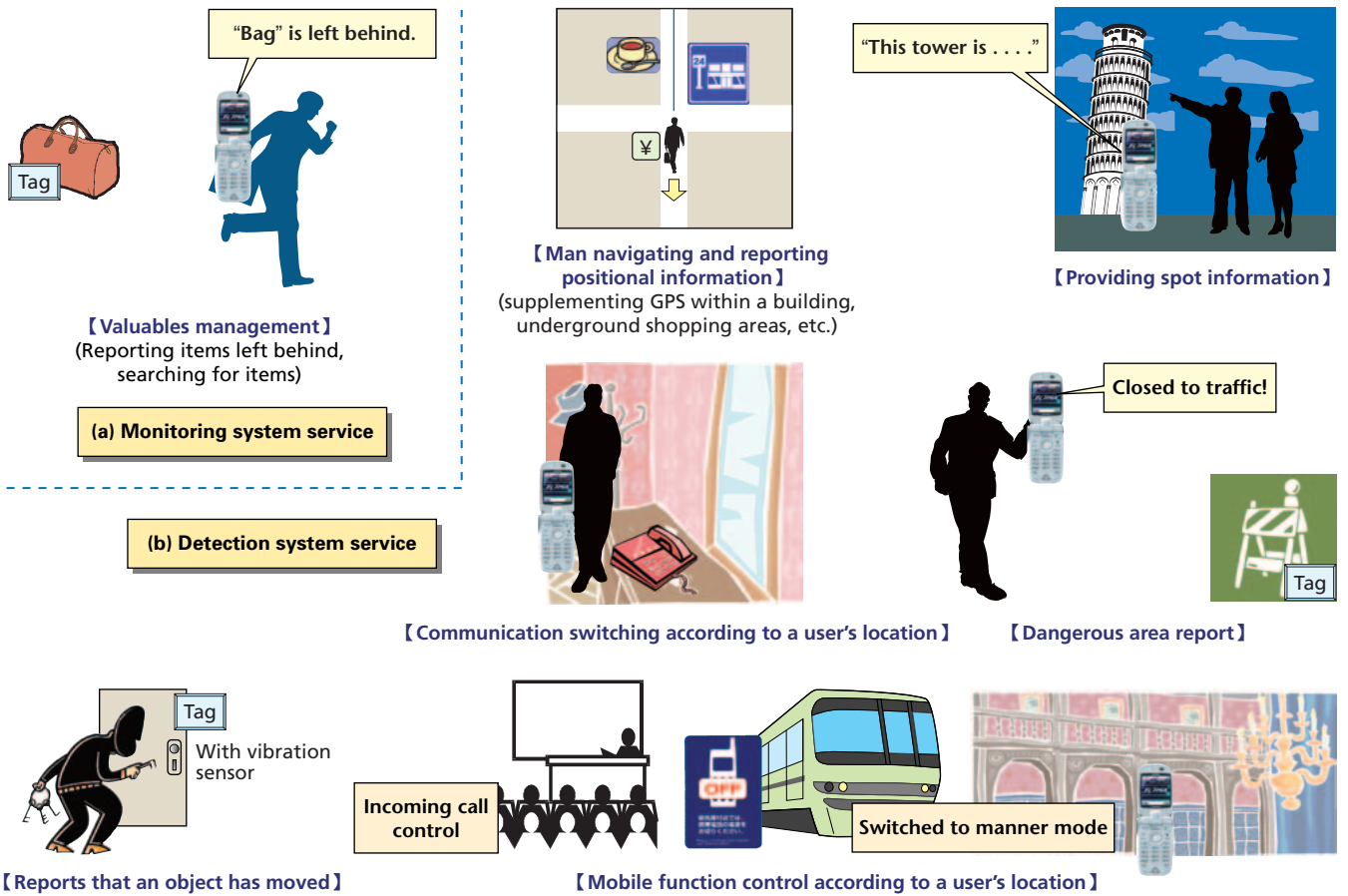

Figure 2 Service examples

tent reception operations.

The principle for generating the TH sequence is described below. As an example, generation of a TH sequence with a cycle of 7 is shown in **Figure 3**. Two blocks (k_1, k_2) are obtained by selecting three sequential bits from the Least Significant Bit (LSB)^{*3} side of an ID. Each block is converted to the elements of a Galois field^{*4} $GF(2^3)$ to obtain the coefficients in Formula (1). Both \hat{k}_1 and \hat{k}_2 are prime power representations corresponding to each element of k_1 and k_2 .

$$P_{(x)} = x^2 + \hat{k}_2 x + \hat{k}_1 \quad (1)$$

By sequentially substituting x in Formula (1) with an element $\{1, 2, 3, 4, 5, 6\}$ of $GF(2^3)$, a TH sequence $\{S_j\}$ is derived with values obtained by calculations that follow a rule such that

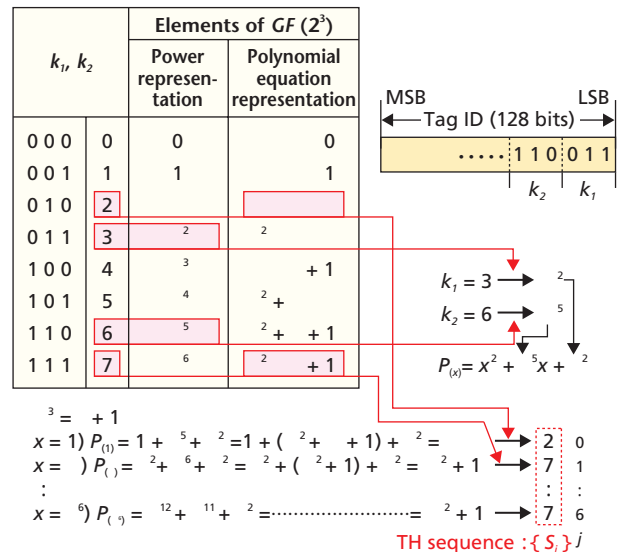

Figure 3 Example of generating TH sequence (cycle 7)

*3 LSB: Least significant bit. Most significant bit is MSB.

*4 Galois field: A field that contains a finite number of elements, and which is closed under the four basic arithmetic operations, such as {0, 1, 2, 3, 4}; it can be considered as the set of remainders obtained by dividing integers by a prime number (e.g., 5). It is commonly used in coding theories, etc.

the sum of items having the same power index equals zero (for example, $2^2 + 2^2 = 0, 1 + 1 = 0$).

Figure 4 shows an example of TH transmission by a tag and the reception operation of a reader. Assigning a value S_j to the generated TH sequence as the slot number to be transmitted, the tag transmits an ID and the phase information j of the TH sequence. The reader performs continuous reception operations until the first ID is received by monitoring. The TH sequence is generated based on the received ID in the same way as in the tag. Furthermore, subsequent ID reception timing is estimated based on the phase information [2]. In this way, intermittent reception operations are performed only at the estimated timing

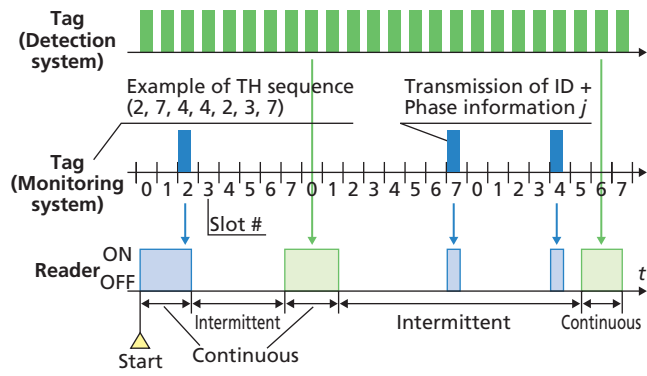

Figure 4 Example of TH transmission by tag, and reception operation of reader

of receptions.

In order to receive a detection system service simultaneously, the reader performs continuous reception operations to receive IDs for detection system services. The tag transmission frequency for the detection system service is different from that of the monitoring system service.

2.2 Multiple Zero-Crossing Demodulation using Under-Sampling

This technology is multiple zero-crossing demodulation, which deals with degradation of reception quality level caused by frequency shifts and enables both the simplification of reception equipment structure as well as digitization to reduce power consumption. A zero-crossing demodulator detects a binary symbol^{*5} by first detecting the direction of a Frequency Shift Keying (FSK)^{*6} signal prior to being converted into a carrier frequency band crossing In-phase/Quadrature-phase (I/Q)^{*7} axis, that is, the direction (from High-to-Low or from Low-to-High) of the level change of each of the I and Q signals (**Figure 5**). However, as the frequency shift becomes larger, the phase transition of the FSK signal within one symbol period equal to or more than $\pi/2$ [rad] does not exist. As a result, crossover of the I/Q axis disappears (zero-crossing disappearance), causing the increase of symbol errors. Therefore, multiple zero-crossing

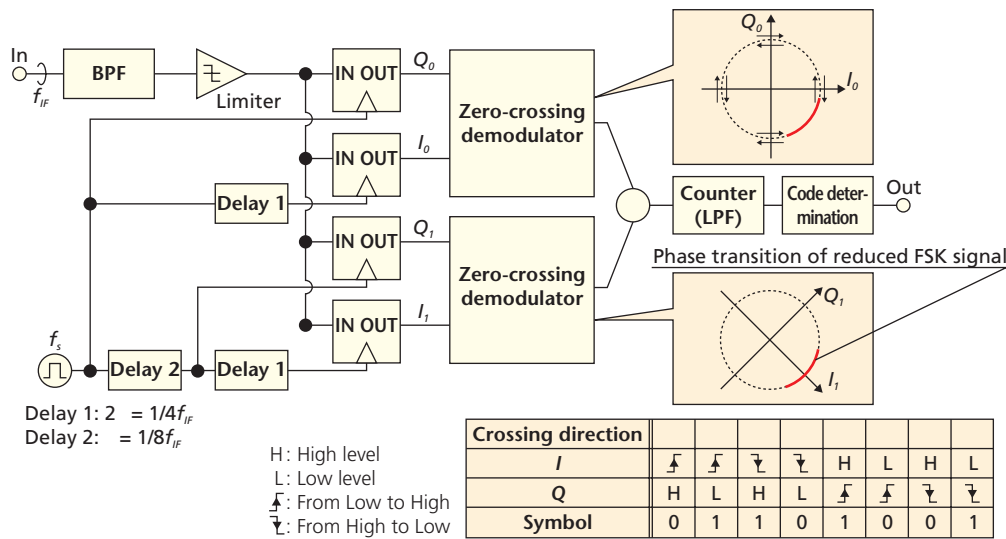

Figure 5 Configuration of receiver (demodulator and perimeter)

*5 Symbol: In this article, the smallest unit of data to be transmitted. One symbol consists of n bits (where n is a positive integer).

*6 Frequency Shift Keying: A digital modulation method to transmit a digital signal by associating it with different frequencies (speeds of different phase transitions).

*7 I/Q: In-phase and quadrature component of the complex digital signal.

demodulators are provided to reduce the number of zero-crossing disappearances by providing multiple I/Q axes of different angles. The frequency shift is caused by the fact that the frequency accuracy of an oscillation system using a Surface Acoustic Wave (SAW) resonator^{*8} is low. However, since SAW resonators are widely used for commercial tags and weak-output radio modules, their use is necessary to enable the miniaturization and cost reduction of tags.

A possible configuration of a receiver applying this technology using the case of a multiplication factor of 2 is shown in Fig. 5. A received signal with the frequency converted into an Intermediate Frequency (IF)^{*9} range is input to a limiter through a Band Pass Filter (BPF)^{*10}. The carrier frequency of an active RFID reader is generally in the 300 MHz range, and since it is difficult to produce a small-sized BPF having the required bandwidth (Formula (2)) in this frequency range, frequency conversion to an IF range is required. Multiple zero-crossing demodulation occurs by performing under-sampling of the FSK signal at different and multiple timings after conversion into a binary signal by the limiter [3]. With this configuration, since binary conversion is performed within the IF range, unlike conventional configurations [4] [5], a digital configuration which requires neither Automatic Gain Control (AGC)^{*11} nor an analog-to-digital converter can be used after the IF range, enabling reduced power consumption.

In order to prevent aliasing^{*12} of unnecessary frequencies from being generated (other than the received signal by under-sampling), sampling frequency f_s must satisfy Formula (2).

$$f_s = f_{IF} / N > BW \quad (2)$$

In this formula, f_{IF} is the central frequency of the IF range, N is the divider ratio^{*13} integer of 1 or greater, and BW is the bandwidth of the BPF. In addition, time difference of samplings is given in Formula (3), where M is the multiplication factor.

$$= 1/4 M f_{IF} \quad (3)$$

3. Prototype External RFID for Mobile Terminal

An exterior view of prototype active RFID reader is shown in **Photo 1**, and basic specifications are shown in **Table 1**. To not only evaluate the effectiveness of the devised technologies for reducing power consumption, but also to enable actual experience of the services as shown in Fig. 2, a prototype RFID reader was equipped with an interface and shape capable of external attachment to a mobile terminal (N902i). In addition, a dielectric chip antenna^{*14} was set on the circuit board of the reader.

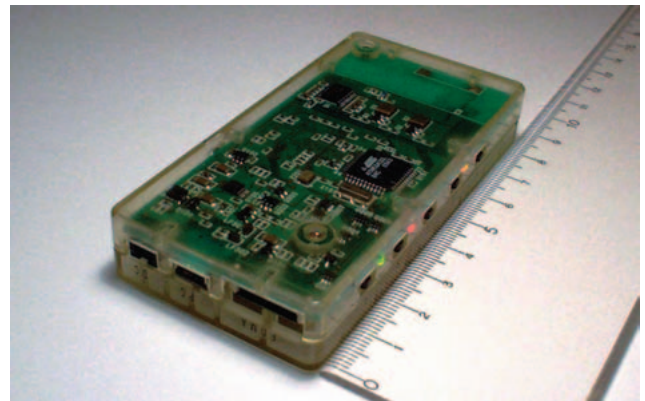

Photo 1 Exterior view of prototype RFID reader

Table 1 Basic specifications of prototype RFID reader

Frequency	314 MHz, 315 MHz, 2 channels
Transmission power	Weak (Radio Law 4-1)
Transmission speed	9.9 kbit/s, 99 kbit/s to be selected
Access distance	10 meters, maximum (at 9.9 kbit/s)
Modulation/demodulation	Binary FSK/Asynchronous demodulation (section 2.2)
Encoding type	NRZ
ID	128 bits
Transmission packet structure	ID + Phase Information (3 bits) + CRC (16 bits) Applied with FEC Packet Length: 26.7 ms (at 9.9 kbit/s)
Size, weight	45 × 89 × 16 mm, 45 g

Cyclic Redundancy Check (CRC): Error detection method capable of detecting errors generated during data transmission.

Forward Error Correction (FEC): A system where redundant information is added on the transmitting side, and errors generated during data transmission are corrected using the redundant information on the receiving side.

*8 SAW resonator: An oscillator circuit method for a radio module integrated as a high-frequency component of radio equipment. Mainly, there are the crystal method and SAW resonator method for oscillator circuits, and a SAW resonator is used because of low cost, even though frequency stability is somewhat inferior to that of the crystal method.

*9 IF: A frequency that a signal of multiple frequency channels is converted into during demodulation. By making this frequency lower than the carrier frequency range, a filter for the required bandwidth can be easily constructed, so that only the required signal is selected and extracted.

*10 BPF: A filter allowing only a specific frequency band to pass.

4. Effectiveness

The effectiveness of the two devised technologies evaluated by the prototype RFID is described below.

4.1 TH Access/Intermittent Reception Control Method

Figure 6 shows the voltage variation characteristics of the reader battery and Table 2 shows the continuous collision generation rates for an ID. The tag settings were average transmission interval of 1 second, TH sequence cycle of 7, and transmission speed of 9.9 kbit/s for each ID. Since collision frequency was being evaluated, the transmission speed was set to 9.9 kbit/s to provide a longer transmission packet length. A speed of 9.9 kbit/s is applicable for services requiring an access distance of about 10 meters.

1) Effectiveness of Power Consumption Reduction

As seen from Fig. 6, it is clear that battery life can be extended depending on the number of tags with the devised technologies applied as compared to continuous reception. While a battery lasts for about 9 hours regardless of the number of tags in the case of continuous reception, by applying the devised tech-

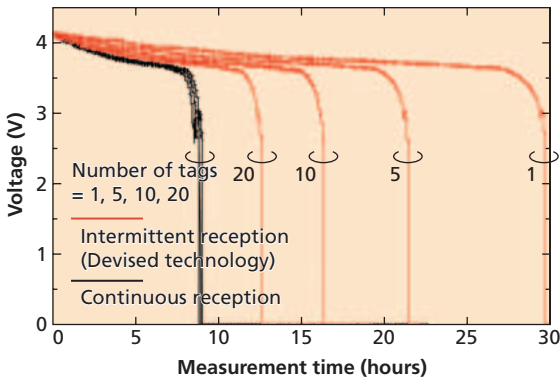

Figure 6 Voltage variation characteristics of battery in trial unit of RFID reader

Table 2 Continuous collision generation rates of Tag ID

Number of tags (Units)	5	10	20
TH transmission (Devised technology)	No occurrence during measurements	0.2	1.65
Periodic transmission (Conventional)	9.8	18.9	40.2

nologies, battery life is about 30 hours for 1 tag, about 21 hours for 5 tags, about 16 hours for 10 tags, and about 12.5 hours for 20 tags [6]. The trial unit incorporates Field Programmable Gate Arrays (FPGAs)^{*15}, therefore about 25% of power consumption during packet reception is consumed during wait-time states, with the above results. However, since power consumption during wait-time can be reduced after chip integration, it is anticipated that further power reduction effects can be expected.

2) Effectiveness of Reducing Continuous Collision rates

Table 2 shows the average value of continuous collision rates obtained for each tag. For this purpose, a continuous collision is defined as a condition when measurements are attempted 100 times in 30 seconds from the time an intermittent reception operation is started in the reader after the continuous reception of an ID by the monitoring system service (Fig. 4), and no ID is received during the attempt. Since differences between transmission start timings of different tags are important, the timings were changed for each trial. Furthermore, reception power from each tag was great enough to ignore a no-reception condition caused by ambient noise. It is clear that continuous collision generation rates can be reduced when the devised technologies are applied. In the case of periodic transmissions, the probabilities of no ID reception for a 30-second duration are about 10% for 5 tags, about 20% for 10 tags, and about 40% for 20 tags. With respect to the above, the devised technologies over 100 trials reduced this probability to 0% for 5 tags, about 0.2% for 10 tags, and about 2% for 20 tags.

4.2 Multiple Zero-Crossing Demodulation using Under-Sampling Technique

Quantitative valuations of power consumption reductions due to the simplification of the configuration and digitization will be clarified further after actual chip integration. In this section, the effectiveness regarding improvements of resistance properties against possible frequency shifts will be described.

Required reception power characteristics to prevent frequency shifts are shown in Figure 7. Communication speed was set to 99 kbit/s, which is more vulnerable to frequency shifting than a rate of 9.9 kbit/s. The required reception power is defined as

*11 Automatic Gain Control: A function to automatically control the amplitude of an output signal to remain constant.

*12 Aliasing: A distortion caused by a part of a sampled signal being mixed with a frequency component of the original signal when performing sampling with a frequency lower than twice the one side of the frequency bandwidth of a transmission signal.

*13 Divider ratio: Ratio obtained when a clock frequency or the like is converted into a frequency obtained by dividing the original frequency by an integer.

*14 Chip antenna: A type of antenna with a flat and rectangular shape. Widely used with a mobile terminal due to its miniaturization and light weight.

*15 FPGA: A large-scale integrated circuit capable of being rewritten, consisting of cells arranged in the shape of an array and wiring elements.

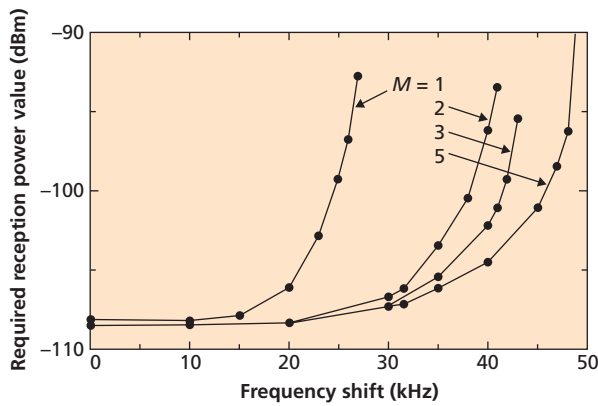

Figure 7 Required reception power characteristics against frequency shift

reception power measured at the output end of the reception antenna when the ID no-reception rate becomes 10^{-2} . It is clear that resistance properties against frequency shifts are improved as the multiplication factor M is increased. Even in the case of a multiplication factor of 2, with respect to -108.4 dBm of required reception power at the time of no frequency shifts, the required reception power with frequency shifts of ± 100 ppm (parts per million) (± 31.5 kHz at 315 MHz) is -106.2 dBm, with the resulting required reception power being suppressed by about 2 dBm.

Furthermore, since sampling is performed in the IF range using this demodulation method, the pattern effect^{*16} can be avoided, resulting in realization of a uniform reception quality level uninfluenced by ID bit patterns.

Figure 8 shows ID no-reception rate characteristics for an ID consisting of symbol 0 and 1 being repeated alternately (hereinafter referred to as ID_A), and for an ID consisting of the same symbol for all 128 bits (ID_B). Communication speed used during trials was 99 kbit/s, as before. The frequency components of ID_A are concentrated around the frequencies at which 1 and 0 are alternately repeated, while the frequency components of ID_B are concentrated around 0 Hz due to no voltage change as a result of the same symbol being repeated. Accordingly, the high frequency components of ID_A are greater than those of ID_B, resulting in the Low Pass Filter (LPF)^{*17} passing less power for ID_A than for ID_B. This is

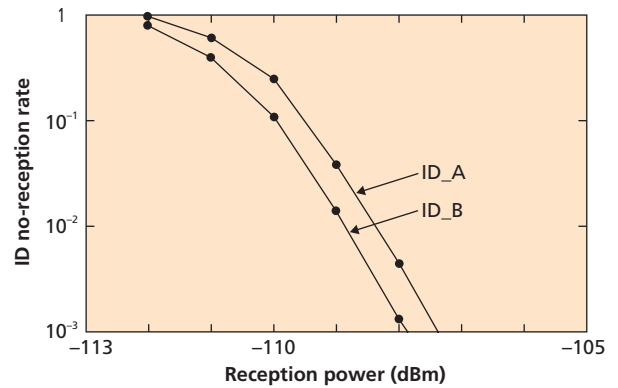

Figure 8 ID no-reception rate characteristics

considered as the reason for generating a difference in the level of reception quality between ID_A and ID_B. However, it is believed that this difference can be further lessened by adjustment of the LPF after demodulation. As described above, even when Manchester encoding^{*18} and the like are not used, uniform reception quality levels can be obtained even with Non-Return to Zero (NRZ)^{*19} encoding. NRZ encoding enables the frequency shift keying of the tag's SAW generator to not be unnecessarily enlarged. As a result, it is possible to assign the entire realizable frequency shift keying to transmission. When the amount of phase transition with Manchester encoding is the same as NRZ encoding, communication speeds for NRZ encoding can be twice those of Manchester encoding. Accordingly, the time required for transmitting an ID is reduced by one-half, resulting in reduced collision rates and lengthened battery life.

5. Conclusion

In this article, technologies devised aiming at reduction of power consumption required for mounting an active RFID reader on a mobile terminal have been described. Based on evaluation results of a prototype RFID reader, it is expected that power consumption can be reduced without degrading the level of reception quality. With the monitoring system service, power consumption can be further reduced by application of intermittent reception. After chip integration, it is expected that a reader applying this technologies can be mounted on a mobile terminal without reducing battery life.

*16 Pattern effect: Level fluctuation occurring when the same symbols are continued in a transmission system after the direct current is powered off. If level fluctuation is generated, bit errors are increased.

*17 LPF: A filter allowing a low frequency band to pass.

*18 Manchester encoding: A method of transmitting symbols in which "0" is transmitted as a pulse level change from high to low, and "1" is transmitted as a level change from low to high. Twice the bandwidth is required as compared with NRZ encoding.

*19 NRZ: A method of transmitting symbols such that a pulse is transmitted for each symbol, using voltage values corresponding to "0" as low and "1" as high.

REFERENCES

- [1] K. Imai et al.: "A New Direction in 4G Infrastructure Research—Growth into a Ubiquitous World—," NTT DoCoMo Technical Journal, Vol. 6, No. 3, pp.4–15, Dec. 2004.
- [2] K. Takiishi, S. Ohkubo and H. Suda: "Random Access and Intermittent Reception with Time Hopping," Proc. of IEICE Society Conference, B-5-204, Sep. 2003 (In Japanese).
- [3] S. Ohkubo and H. Suda: "Multi-Zero-Crossing Demodulator Using an Under-sampling Technique," Proc. of IEICE General Conference, B-5-205, Mar. 2004 (In Japanese).
- [4] E. K. B. Lee and H. M. Kwon: "NEW BASEBAND ZERO-CROSSING DEMODULATOR FOR WIRELESS COMMUNICATIONS, PART-I: PERFORMANCE UNDER STATIC CHANNEL," Proc. of IEEE MILCOM, pp. 543–547, 1995.
- [5] S. Samadian, R. Hayashi and A. A. Abidi: "Demodulators for a Zero-IF Bluetooth Receiver," IEEE J. Solid-State Circuits, Vol. 38, No. 8, pp. 1393–1396, 2003.
- [6] K. Takiishi, S. Ohkubo, T. Sugiyama and N. Umeda: "Power Consumption Reduction by Random Access and Intermittent Reception with Time Hopping," Proc. of IEICE Society Conference, B-5-101, Sep. 2005 (In Japanese).